

2 610 907 273

Stand } 08-05
Issue } 00-08-10

Fig./Abb. 1

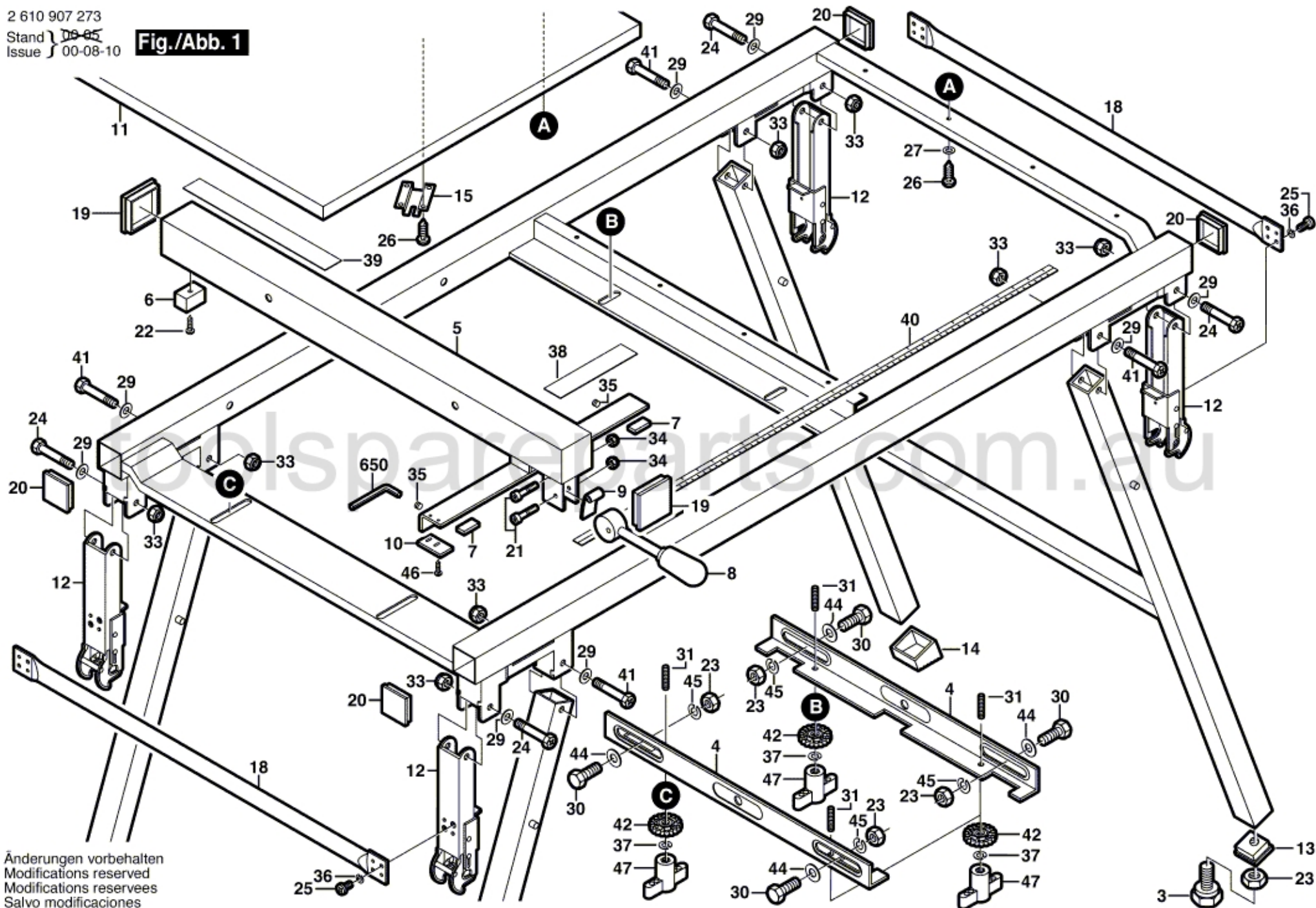

Änderungen vorbehalten
Modifications reserved
Modifications reserves
Salvo modificaciones